







30 min

«Achtung! Im Falle einer Reklamation bitte unbedingt das entsprechende Teil auf der der „Explosionszeichnung“ (Seite 2) einkreisen und diese Seite zur Verfügung stellen! Dies sichert eine reibungslose Abwicklung»

ASSEMBLY INSTRUCTION

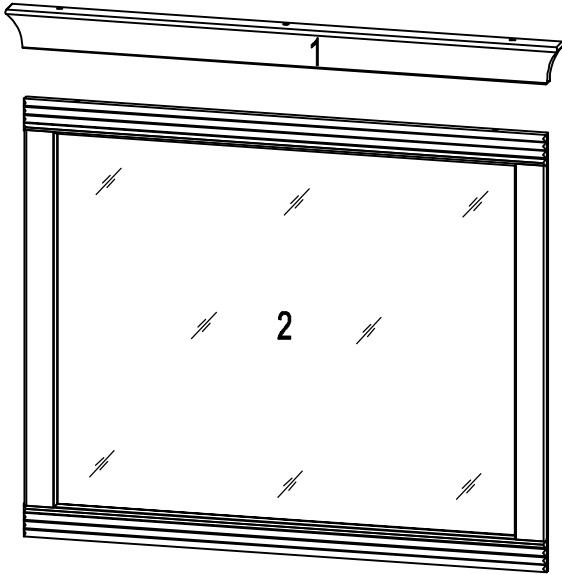
A=2  Ø8x32	B=4  3.5x15	C=3  4x50	D=2 
--	---	---	---

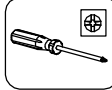

1	B=4  3.5x15	D=2 	
----------	---	---	---

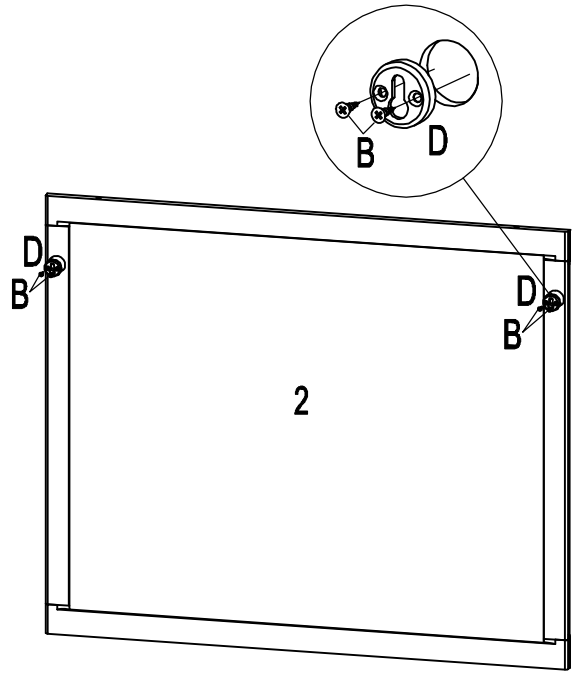

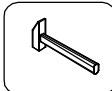
2	Ax2  Ø8x32	Cx3  Ø4x50		
----------	--	--	---	---

